

# S-200

BEAUTIFULLY  
ENGINEERED  
ALUMINIUM  
DOORS



**SPITFIRE**  
DOORS

MAKE A GRAND ENTRANCE





S-200. WHERE FORM MEETS FUNCTION

1654

**The S-200 Series, Spitfire's series of beautiful designer entrance doors, represents one of the most comprehensive ranges of aluminium residential doors in the world.**

For over ten years now, these incredibly secure, stylish, contemporary designer doors have established an unrivalled reputation with the most discerning customers across Europe and also in the very hot and challenging climates of Africa and far east Asia.



1280



1581



# SPITFIRE DOORS

MAKE A GRAND ENTRANCE



1175

These beautiful designer entrance doors also seamlessly fuse outstanding aesthetic appeal with state-of-the-art engineering, being meticulously constructed from carefully bespoke designed aluminium sections combined with Winkhaus German engineered precision locking systems – from a 5-bolt hooklock right up to auto-locking.

A sleek black 20mm low threshold comes as standard and a 15mm threshold packer is an option if more clearance is

required at floor level. While all door models incorporating glass feature double glazing with laminated safety glass, and the inside door face plain without decoration as standard. Side and toplights are double glazed, also with laminated safety glass.

Together, this provides you with the perfect synthesis of beauty, technology, security, insulation, durability and exclusivity.

# ENTER THE EXCLUSIVE WORLD OF SPITFIRE DOORS

Spitfire Doors was originally established in response to the increasing demand for exclusive, secure, beautifully engineered doors and currently offers the widest range of high-end residential entrance doors in Europe, with many different door styles to choose from and quality designed to last a lifetime.

All designs are exclusive to Spitfire and, in conjunction with our authorised Design Partners, we offer comprehensive survey and installation coverage right across the UK and Ireland. You can even choose a flat flush outerframe or an elegantly curved one.

## EXTRAORDINARY AND UTTERLY EXTRAORDINARY

We have showcased the S-200 Series of beautiful designs here. We are confident that these designs will provide you with the flexibility you require along with extraordinary levels of quality and remarkable aesthetics. Alternatively, if you're looking for a door that's even more out of the ordinary, we can also create a bespoke door that's uniquely yours.



1170



1654

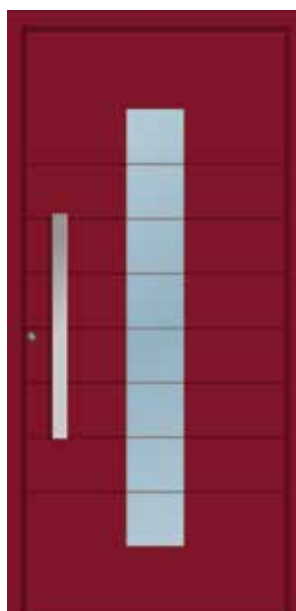

1185



1651



1190

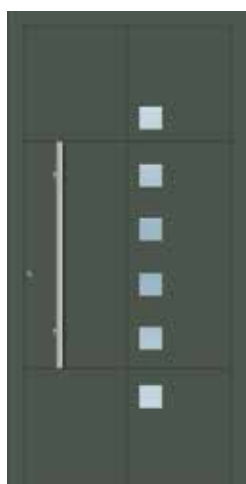

1150



1165



1180



1736



## SIMPLE, COMPLEX, LINEAR OR CURVED

With Spitfire, of course, you have the option of buying the exact door that you have seen in one of our Design and Installation Partners' showrooms or you have the freedom to design your own door.

Not only that but current trends are also accommodated since our beautiful S-200 Series aluminium doors can be made on an imposing scale, up to 1150mm in width and an impressive 2250mm in height, plus toplights and sidelights!

In fact, with such an enormous range to choose from, including doors with sidelights, toplights, double doors and French doors, it's fair to say that there's a Spitfire S-200 door to suit every kind of property, whatever your personal style and taste in décor.

## IMPECCABLE STYLE, IMPREGNABLE SECURITY

A casual glance at a Spitfire S-200 door reveals its beauty. And yet the real beauty of a Spitfire door can be found in its engineering. Each S-200 door sash features subtle micro-adjustment devices in the head and base of the door to allow for fine tuning during installation.

Our door is a substantial 64mm thick with no less than three layers of glass making it hardly surprising that every S-200 door conforms to RC1 levels of security and weathering, specified by the IFT Rosenheim Test Institute in Germany.

## DIGITAL PEEPHOLE



1295



1315

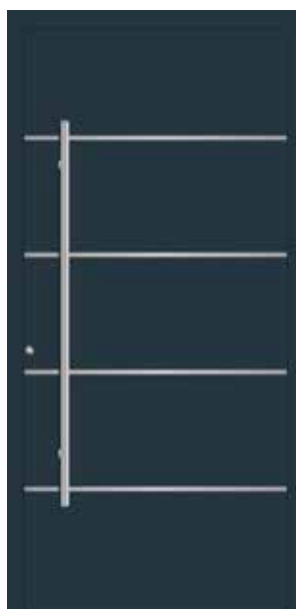

1310



1360



1361



1362

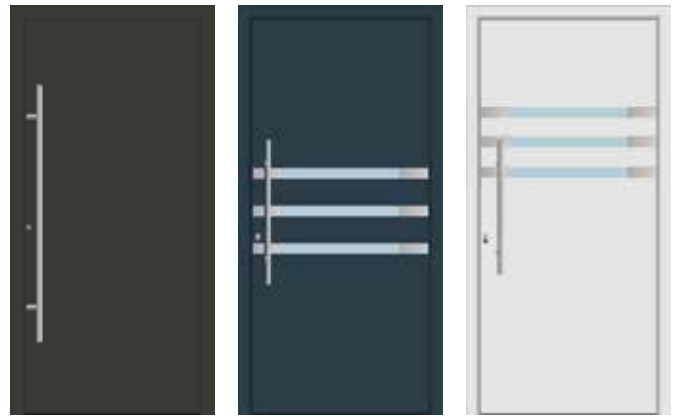

1195

1285

1290

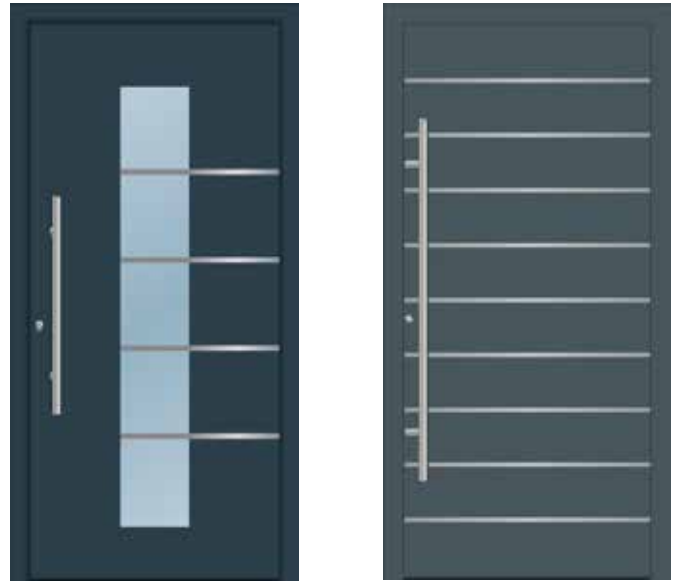

1305

1641

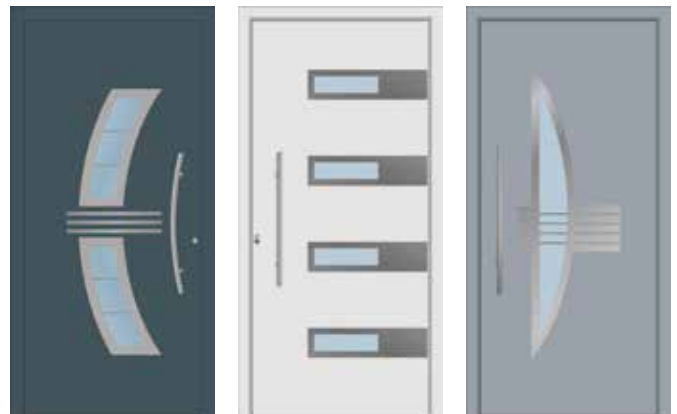

1320

1325

1330

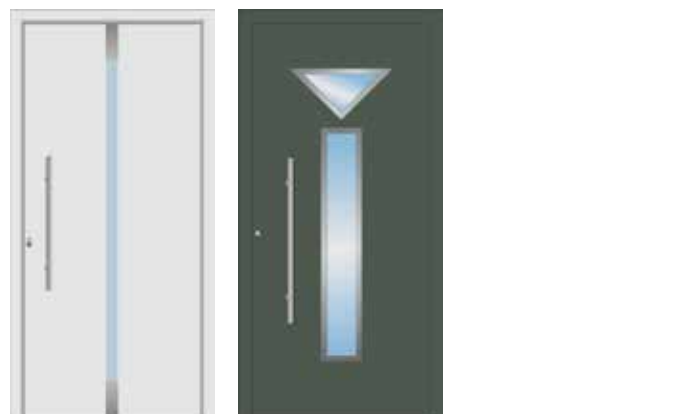

1355

1363

## LOWER U-VALUES, LOWER ENERGY BILLS

Just to get a little technical for a moment, U-values are used to measure how effective building products are in preventing heat being lost from inside a building.

In a nutshell, the lower the U-value of a door, the more slowly heat can escape through it, which means the door provides better insulation so that less energy, and therefore of course less money, is needed to heat your home. And Spitfire S-200 Series aluminium doors outperform composite doors with U-values as low as 1.2 W/m<sup>2</sup>K (trust us, that's pretty low!)

Which means, to sum up, that these doors will both look great and keep you safe, reducing your domestic running costs and protecting the environment both inside and outside your beautiful new front door.

# INTERNAL HANDLE



BRUSHED STEEL

# BRUSHED STEEL EXTERNAL HANDLES



SQUARE BAR



OVAL BAR



ROUND BAR



1364



1365



1366



1715

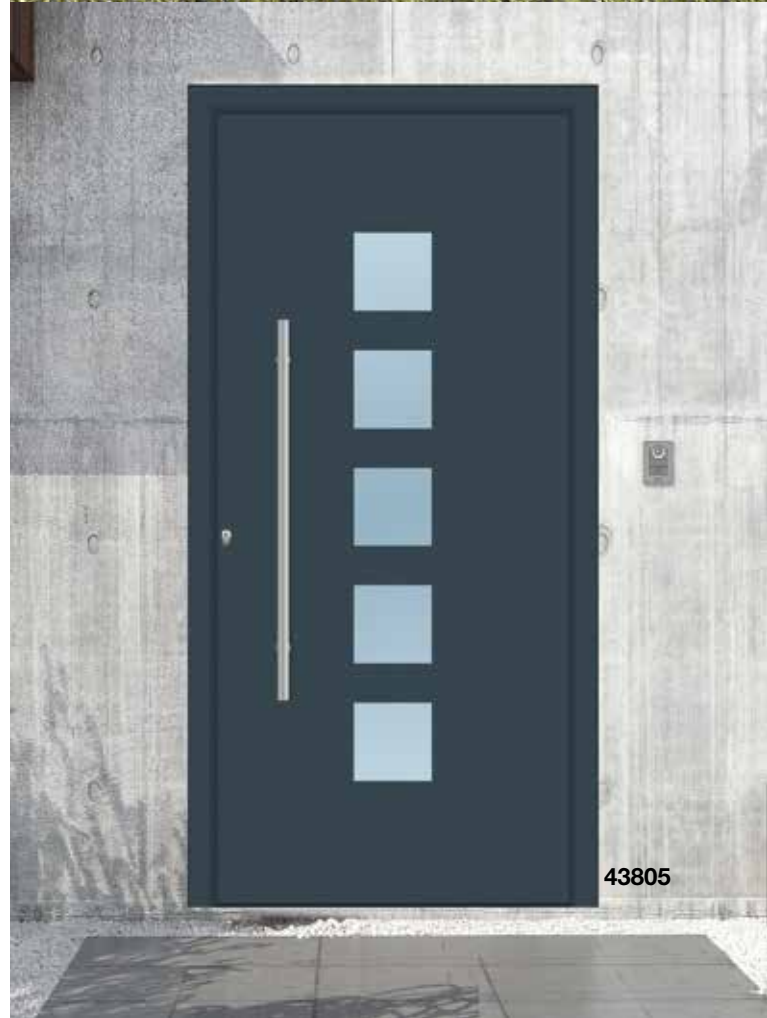

43805



1175



43804

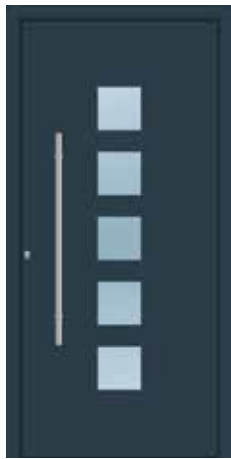

43805



43806



43811



1125

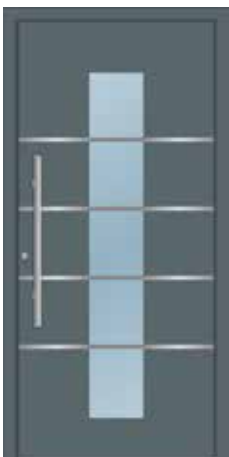

1300

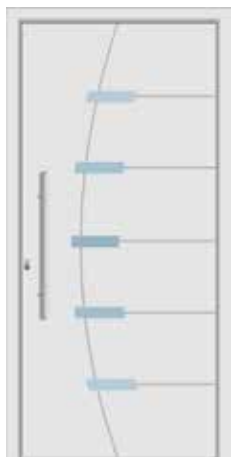

1621



1155



1631



# GERMAN LOCKS

You have the option to upgrade from our standard 5-point locking system with hooks. Why not consider our discreet EntryGuard, which allows you to partially open the door to screen visitors, or maybe upgrade to our 'slam-shut' lock, which throws all the hooks automatically as the door engages in the outerframe.

A very useful option is our Day-Latch, which allows you to enter easily without a key, until you need to lock your door securely by flicking a small lever.

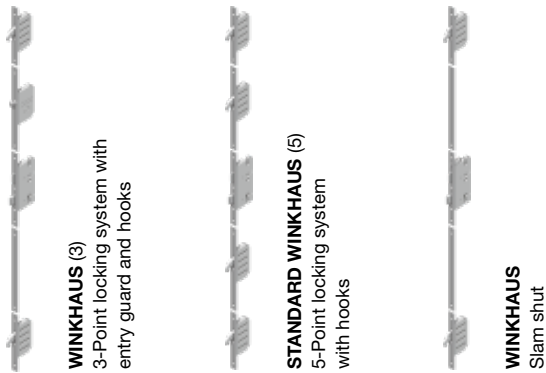

1591



1747



1715



1717

## DAY LATCH OPTION

At the flick of a switch, this device enables you to leave the door on the 'latch'. Simply flick the switch back and the door is totally secure again.



AV3 LATCH



1721

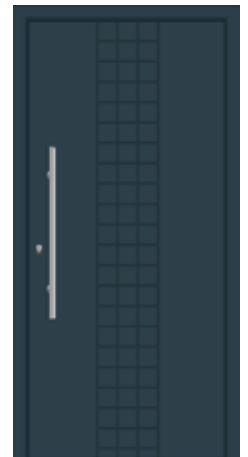

1725

## WINKHAUS ENTRYGUARD

A purpose designed extra locking system with integral guard bar. Far stronger than a flimsy door chain and can be left permanently engaged. Provides perfect peace of mind when answering the door.



ENTRYGUARD



ENTRYGUARD ENGAGED



1732

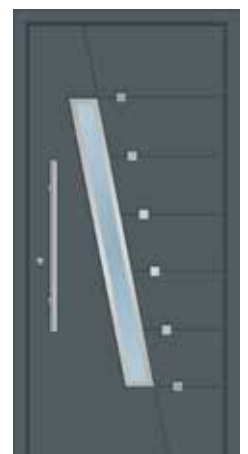

1661

## CROSS SECTIONS

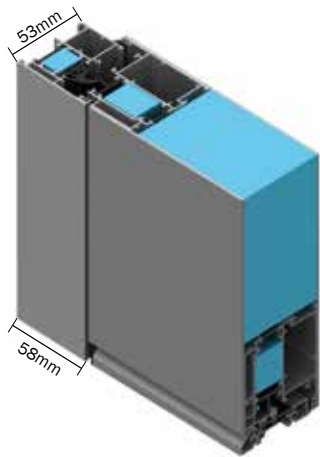

**FLAT  
OUTER  
FRAME**  
53mm

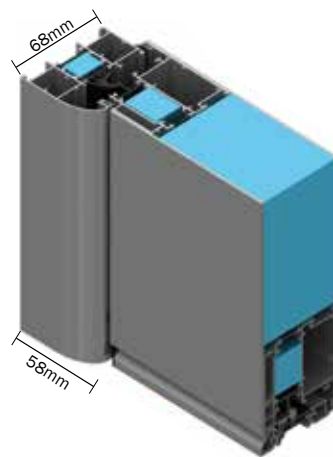

**CURVED  
OUTER  
FRAME**  
68mm

### FLAT OUTER FRAME

Maximum door width 1150mm  
Maximum door height 2250mm

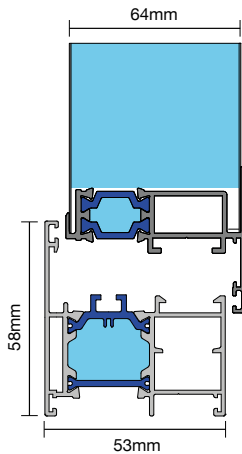

### CURVED OUTER FRAME

Maximum door width 1150mm  
Maximum door height 2250mm

\*Sidelights can only be supplied with curved frame.

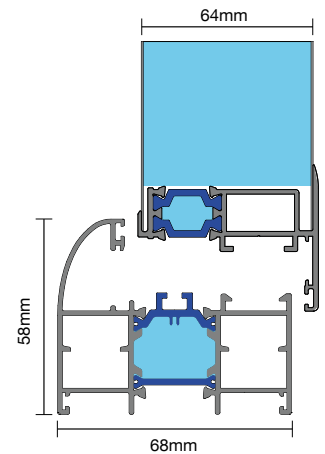

## OUR STANDARD FINISHES



ANTHRACITE GREY RAL 7016    MID GREY RAL 7040    LIGHT GREY RAL 7035    PURPLE RED RAL 3004    BLACK RAL 9005    CREAM RAL 1015    WHITE SEMI-GLOSS

## WOOD EFFECT EXAMPLES



T210    T250    T260    T270    T290    T310    T320



T510    T520    T630

## THRESHOLD DETAIL

15mm Threshold packer available

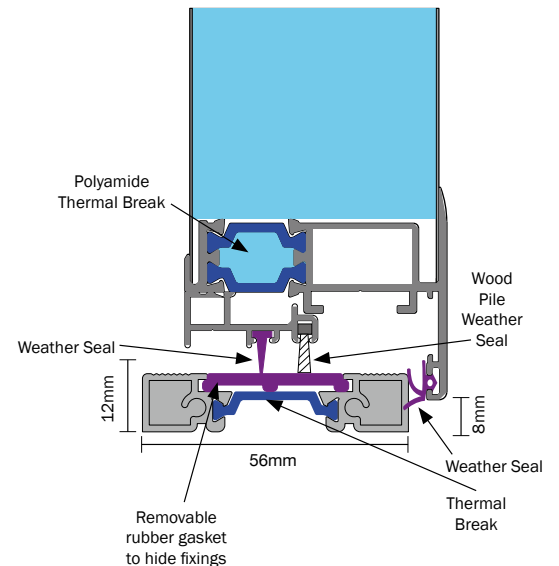

## ENDURING BEAUTY

Each S-200 Series door comes with an extremely resilient powder coated paint finish to guarantee colour stability, weather resistance and low maintenance, plus triple seals helping to keep the very worst of our climate's vagaries at bay.

There's a choice of hundreds of RAL colours, in gloss, matt, metallic, dual coloured, or multi-coloured, along with wood effects and many textured finishes.



**SPITFIRE  
DOORS**

MAKE A GRAND ENTRANCE

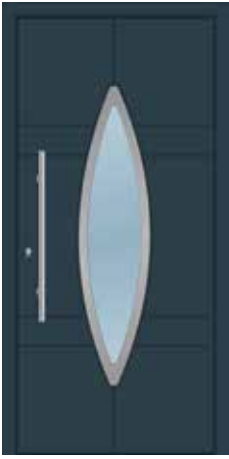

1752



1755



1757



1765



1130



1671

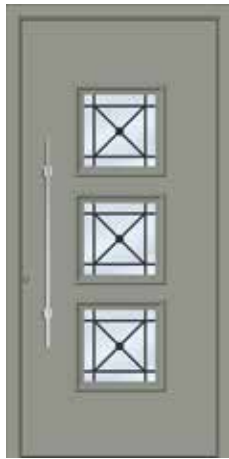

1140

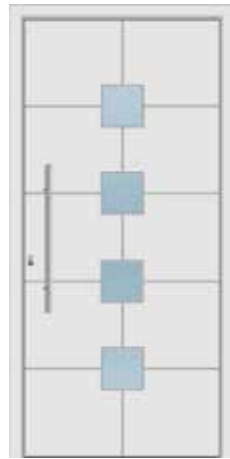

1712



1710

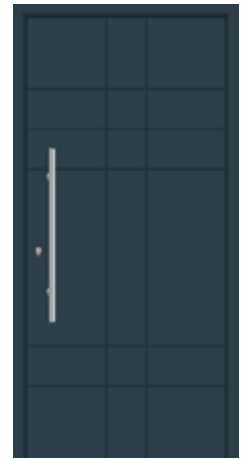

1740

## DECISIONS, DECISIONS

In addition to the myriad of options available in terms of style, finish and security, the S-200 Series also comes with a choice of glass and handles, so it's fair to say that there really is a Spitfire S-200 front door to suit every property.

Not only that but, when you order an entrance door from Spitfire, we explain all these options to you. And, whatever options you choose, we deliver your door ready fitted with your chosen extras in the finish of your choice.



1767



1762





# OUR SHOWROOM PARTNERS. SELECTED AND AUTHORISED BY SPITFIRE

You'll be in good hands with our Design Partners. Because Spitfire Doors has appointed a national network of over 50 authorised Design and Installation Partners, many with showrooms, so you can get up close and personal with the Spitfire range for yourself. Our Partners can discuss your requirements, measure up your property and install your beautiful new front door without fuss or mess.

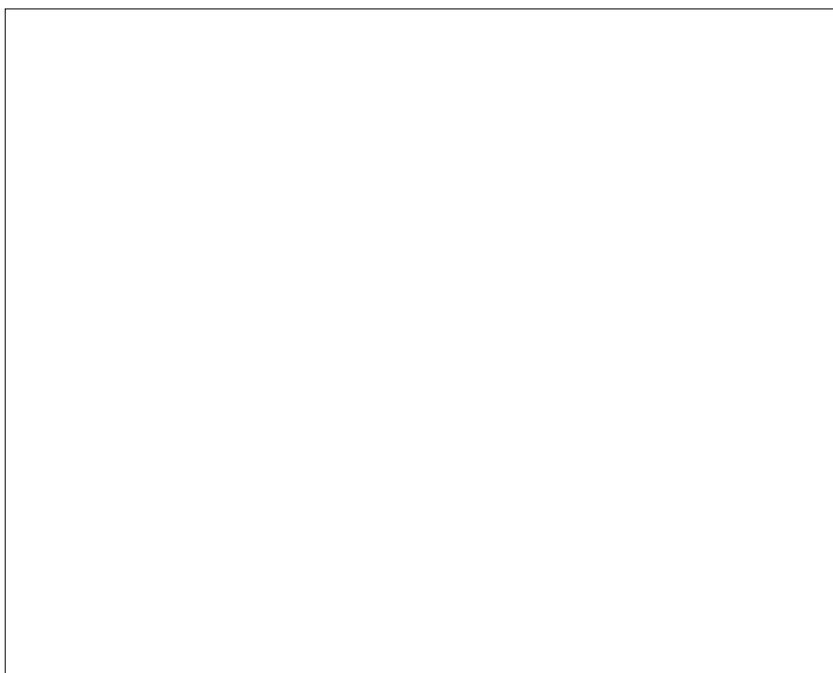

**SPITFIRE  
DOORS**

MAKE A GRAND ENTRANCE